

EVAPORADOR DE DOBLE FLUJO INDUSTRIAL / INDUSTRIAL DUAL DISCHARGE EVAPORATOR

EXA / EXR / EXC.: 12 KW - 57,5 KW

CUANDO POTENCIA Y COMFORT CAMINAN JUNTOS

- Esta gama consta de 36 modelos de evaporadores industriales de plafón.
- Diseñados para aplicaciones de frío comercial en refrigeración a alta temperatura (serie EXA) disponibles con capacidades frigoríficas entre 23.600 W y 57.400 W, media temperatura (serie EXR) disponibles con capacidades frigoríficas entre 16.560 W y 40.570 W, ó de frío comercial en congelación a baja temperatura (serie EXC) disponible con capacidades frigoríficas entre 12.040 W y 30.560 W.

WHEN POWER AND COMFORT WALK HAND IN HAND

- This range of dual discharge evaporators consist of 36 models.
- Has been designed for commercial chilling applications at high temperature (EXA series) available in cooling capacities from 23.600 W and 57.400 W, medium temperature [(EXR series) available in cooling capacities from 16.560 W up to 40.570 W, and for commercial freezing applications at low temperature [(EXC series) available in cooling capacities from 12.040 W up to 30.560 W.



Evaporador industrial de doble flujo frontal
Frontal Industrial dual discharge evaporator



Evaporador industrial de doble flujo lateral
Lateral Industrial dual discharge evaporator

Evaporador industrial de doble flujo
Industrial dual discharge evaporator

CARACTERÍSTICAS TÉCNICAS TECHNICAL FEATURES

BATERÍAS ALETEADAS

- Construidas con tubo de cobre de Ø 1/2" fabricado según las especificación CUPROCLIMA® y con aletas de aluminio corrugadas.
- La disposición de los tubos de cobre al tresbolillo a través de aletas autoseparadas, la perfección del ajuste entre ambos elementos y la utilización de aletas corrugadas permiten la obtención de elevadas eficiencias.
- El paso de aleta es de 3 mm en la serie EXA, de 4,5 mm en la serie EXR y de 7 mm en la serie EXC.

CARROCERÍA

- Está realizada con chapa de acero galvanizado y pintada con pintura epoxy-poliéster polimerizada al horno a 180°C, que le confiere una alta resistencia a la corrosión incluso en condiciones ambientales extremas. Además, este acabado permite cumplir con las más estrictas normas de higiene alimentaria.
- Está dotado de separadores internos para evitar el efecto "by-pass" durante el funcionamiento secuencial de los ventiladores.
- Incorpora doble bandeja de desescarche para facilitar el drenaje del agua resultante del mismo.
- Tanto las bandejas de desescarche como los paneles laterales de la carrocería son fácilmente desmontables, con lo que el acceso al interior de los aparatos es cómodo y rápido.

VENTILADORES Y MOTORES

- Los ventiladores utilizados son de Ø 450 mm. con motores trifásicos (400V / 50Hz.) de rotor externo, 2 velocidades (1.060 y 1.370 r.p.m.). Aislamiento clase B, grado de protección IP-44, que funcionan a temperaturas comprendidas entre -40° y +40°C e incorporan protección térmica.
- Las rejillas de protección son de acero cincado pintado y llevan incorporadas una caja de bornes estanca a la que se conectan los motores de los ventiladores.

FINNED COILS

- Constructed using copper tubes of 1/2" diameter, manufactured according to CUPROCLIMA® specification, and aluminium corrugated fins.
- The staggered arrangement of the copper tubes across selfspaced fins, the accurate link between tubes and fins as well as the use of corrugated fins allow our finned coils to reach high performance.
- Fin spacing is 3 mm in the EXA series unit coolers, 4,5 mm in the EXR series unit coolers and 7 mm in the EXC series unit coolers.

CASEWORK

- The case structure of the unit cooler is fabricated from galvanized steel; its external surface is epoxy-polyester painted and then baked and cured at 180°C (365°F) giving it a high protection against corrosion even in extreme environmental conditions, moreover this casing allows to meet more demanding food hygiene standards.
- Includes double drip tray to make the drainage of the water (resulting from defrost) easier and internal equispaced partitions to avoid the "by-pass" effect caused by the fans sequential operation.
- For better maintenance the drip tray and end plates are readily dismantled from the casework giving an easy and fast access to the inside of the unit cooler.

FANS AND MOTORS

- Fans' diameter is 450 mm and they are equipped with external rotor three-phase motors (400V / 50Hz), 2 different speeds (1.060 and 1.370 r.p.m.). With class B insulation, grade IP-44 protection, thermal protection device and working on a temperature range from -40°C up to +40°C (from -40°F up to +104°F).
- Painted fan guards are made of zinc plated steel wire and support a water tight terminal box where the fans' motors are wired.

RESISTENCIAS DE DESESCARCHE

- Van incorporadas en la serie EXC y son opcionales en la serie EXR. Están blindadas con tubo de acero inoxidable, sus terminales están vulcanizadas sobre el tubo para evitar derivaciones e incorporan toma de tierra individual. En la serie EXA, no existe opción de resistencias, por ser modelos de alta temperatura.
- Se ubican estratégicamente en el evaporador con el objeto de facilitar un desescarche adecuado y uniforme.

CAPACIDADES FRIGORÍFICAS

- Las capacidades frigoríficas de los evaporadores de la serie EXA se determinan según la norma ENV 328 condición 1 (temperatura de evaporación del refrigerante 0°C y temperatura de entrada del aire 10°C), EXR se determinan según la norma ENV 328 condición 2 (temperatura de evaporación del refrigerante -8°C y temperatura de entrada del aire 0°C) y las de los evaporadores de la serie EXC según la condición 3 (temperatura de evaporación del refrigerante -25°C y temperatura de entrada del aire -18°C); en todos los casos con superficie de aleta seca.
- Los restantes valores que aparecen en las tablas están relacionados con diversas temperaturas de evaporación y de cámara frigorífica, en todos los casos en condiciones de aleta húmeda [incremento de un 50% (en la serie EXA), de un 25% (en la serie EXR) y de un 12% (en la serie EXC) sobre los resultados obtenidos con aleta seca].

SELECCIÓN DEL EVAPORADOR

- En las tablas se muestran los valores de capacidad frigorífica para unas DT de 5,78 y 10°C correspondientes a temperaturas de evaporación de 0°C (serie EXA) de -5°C (serie EXR) y de -5°C/-25°C (serie EXC). Si se desea conocer las capacidades frigoríficas para otras condiciones se deben utilizar los diagrama de selección de las páginas 7 y 8.
- Las capacidades frigoríficas de nuestras tablas se han determinado utilizando R-404A. Si quisieramos calcular con otro tipo de refrigerante, partiendo de la capacidad necesaria, debemos de multiplicar la misma por el factor de corrección correspondiente e ir a seleccionar a nuestras tablas con el dato obtenido.

ELECTRIC DEFROST

- Electrical heaters are included in the EXC series and are optional in the EXR series. They are shielded by a stainless steel tube and their terminals are vulcanised over it to avoid electric shunts; every heater includes a single ground wire. In the EXA serie is not option, to be a high temperature model.
- They are strategically located across the finned coil in order to provide suitable and uniform defrosting.

COOLING CAPACITIES

- The stated cooling capacity of EXA series is established according to ENV 328 standard test condition 1 [refrigerant evaporation temperature 0°C and entering air temperature 10°C), for the EXR series unit coolers and the stated cooling capacity is established according to ENV 328 condition 2 [refrigerant evaporation temperature -8°C and air inlet temperature 0°C) and for the EXC series unit coolers is established according to ENV328 standard test condition 3 [refrigerant evaporation temperature -25°C and entering air temperature -18°C); in all cases considering dry fin surface.
- Other stated values for cooling capacities on tables are related to several evaporation and cold room temperatures and are valid for wet fin surface condition [increasing in 50 % (EXA), 25% (EXR) and 12% (EXC) the stated values for dry fin surface].

EVAPORATOR SELECTION

- Shown on the tables are data of cooling capacities for DT corresponding to 5.78 and 10 °C corresponding to an evaporation temperature of 0°C (EXA serie), -5°C (EXR serie) and -5°C / -25°C (EXC serie). For other working conditions, please check with the attached selection chart on pages 7 and 8.
- The cooling capacity has been fixed using refrigerant R-404A. If we would like calculate with other refrigerant, based on the required capacity, we must multiply it by the corresponding correction factor and then go to select on our tables with the data obtained.

REFRIGERANTE REFRIGERANT	R-134a	R-22	R-404A	R-407A	R-407C	R-507	R-410A	R-407F	R-448A	R-449A
F1	1,07	1,038	1	1,17	1,135	1	1	0,83	0,91	0,91

OPCIONES Y ACCESORIOS OPTIONS & ACCESSORIES

MATERIAL DE ALETA

- Aleta de Cobre
- Aleta Lacada

CARCASA

- Pintada
- Acero Inoxidable

DESESCARCHE

- Desescarche por gas caliente
- Desescarche por gas caliente en batería y eléctrico en bandeja
- Desescarche eléctrico (solo para EXR y EXC)
- Desescarche por agua
- Aros de resistencia en el ventilador

OTRAS

- Tratamiento Blygold
- Ventiladores de Alta Eficiencia

REFRIGERANTES

- R134a, R404A, R407F, R448A, R449A...
- Agua Glicolada
- CO2

FIN MATERIAL

- Copper Fins
- Coated Fins

CASING

- Painted
- Stainless Steel

DEFROST

- Hot gas defrost
- Hot gas defrost in coil and electric in tray
- Electric defrost (only for EXR y EXC)
- Water defrost
- Fan ring heaters

OTHER

- Blygold
- High Efficiency Fans

COOLANS

- R134a, R404A, R407F, R448A, R449A...
- Water Glycol
- CO2



OPCIONES Y ACCESORIOS OPTIONS & ACCESSORIES



Ventilador trifásico de rotor externo
External rotor three-phase motor

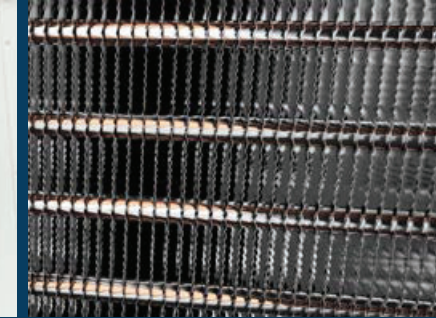

Preparado para CO2, Agua gliconada,
R407F... Ready to use with CO2, Glycol,
R407F, R448A, R449A...

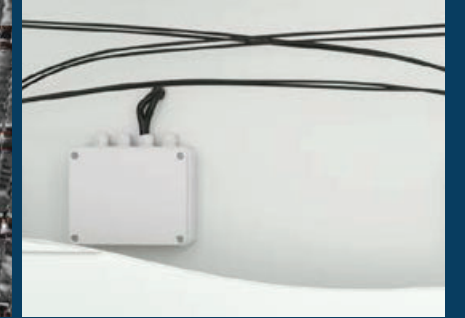

Conexiones eléctricas incluidas
Electric connections included



Salida de aire lateral para mayor comodidad
del trabajador Side air discharge for worker
comfort



Desescarche eléctrico
Electric defrost



Separadores internos para evitar el by-pass
Internal structure to avoid the by-pass effect

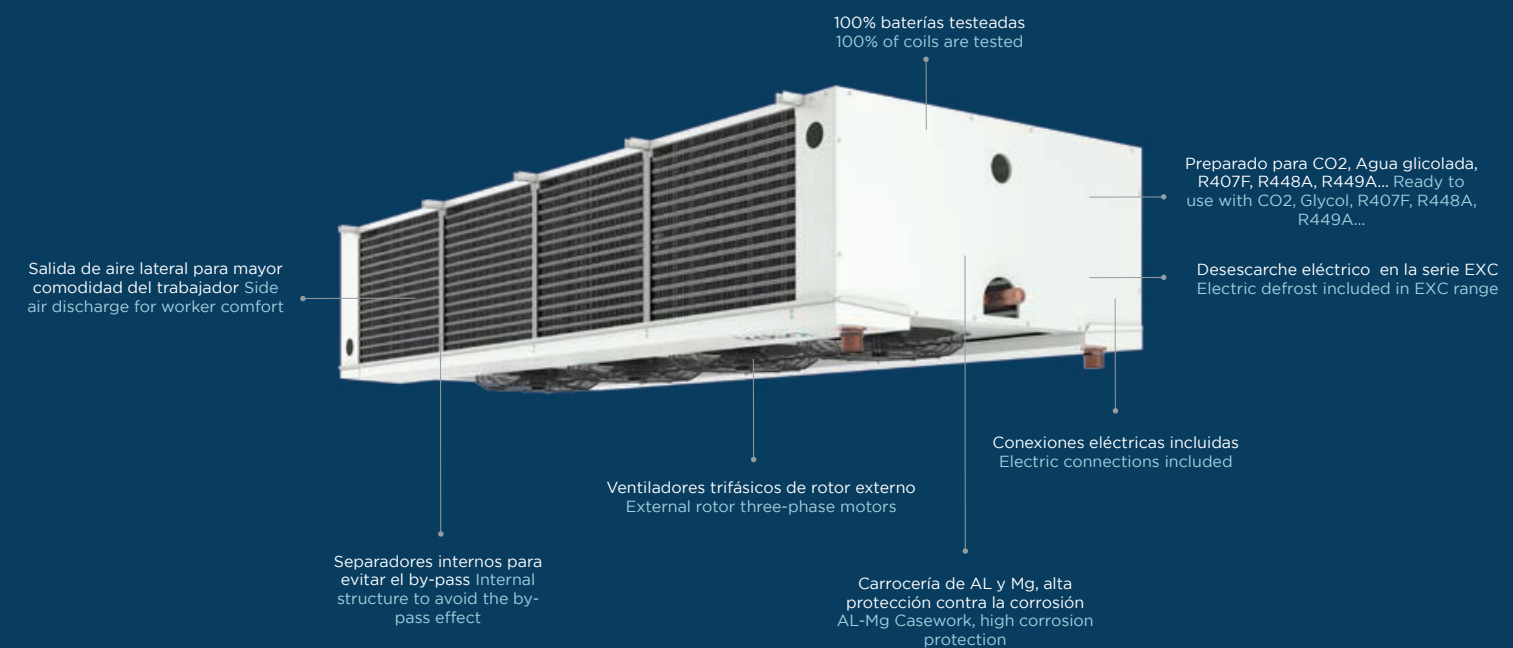

DATOS TÉCNICOS TECHNICAL INFORMATION

SERIE EXA / EXA SERIES

PASO DE ALETAS / FIN SPACING: 3 mm

ALTA VELOCIDAD / HIGH SPEED: 1350 r.p.m.

R-404A

MODELO MODEL	CAPACIDAD CAPACITY	ENV 328 COND.1	Tev = 0°C				SUPERFICIE SURFACE m ²	CAUDAL DE AIRE AIR FLOW m ³ /h	DARDO AIR THROW m*	VOLUMEN INTERNO INTERNAL VOLUME dm ³	PESO WEIGHT kg
			DT1 = 7	DT1 = 8	DT1 = 10	DT1 = 12					
EXA-27	W	20.600	23.300	27.000	33.300	39.500	121	11.800	7	17,5	96
EXA-28	W	21.200	24.100	27.900	34.400	41.000	145,3	11.500	7	22,5	116
EXA-41	W	31.200	35.400	41.000	50.500	60.200	181,6	17.700	7	25	133
EXA-43	W	32.800	37.200	43.100	53.000	63.200	218	17.300	7	36	167
EXA-55	W	41.800	47.600	55.200	67.900	81.080	242	23.600	7	32	176
EXA-57	W	43.600	49.600	57.400	70.600	84.320	291	23.000	7	42	220

EXA

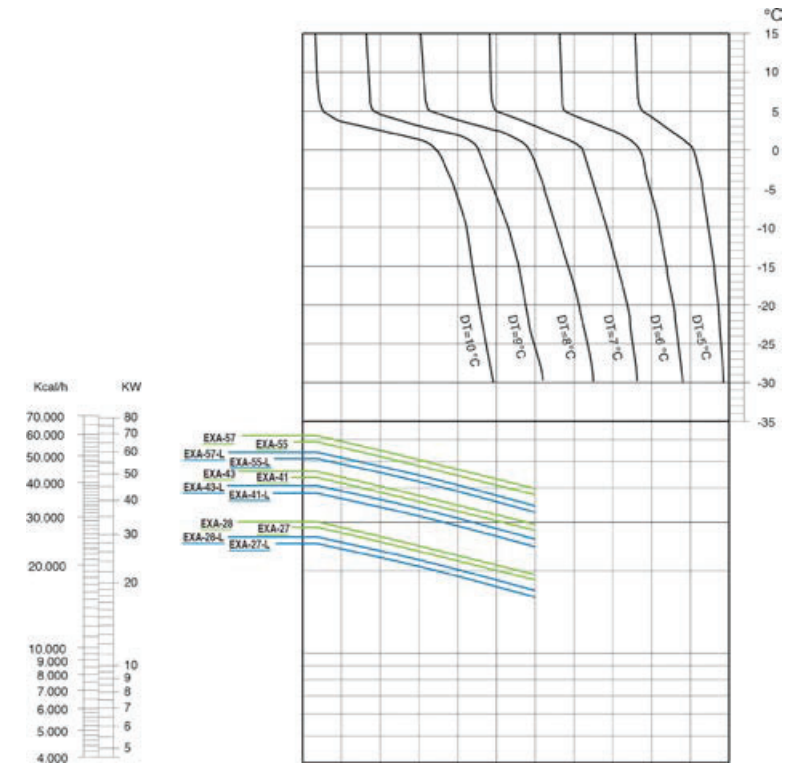

BAJA VELOCIDAD / LOW SPEED: 1000 r.p.m.

R-404A

MODELO MODEL	CAPACIDAD CAPACITY	ENV 328 COND.1	Tev = 0°C				SUPERFICIE SURFACE m ²	CAUDAL DE AIRE AIR FLOW m ³ /h	DARDO AIR THROW m*	VOLUMEN INTERNO INTERNAL VOLUME dm ³	PESO WEIGHT kg
			DT1 = 7	DT1 = 8	DT1 = 10	DT1 = 12					
EXA-27	W	18.000	20.400	23.600	29.100	34.520	121	9.300	5	17,5	96
EXA-28	W	19.000	21.700	25.200	30.900	36.600	145,3	9.000	5	22,5	116
EXA-41	W	27.400	31.100	36.000	44.350	52.600	181,6	13.950	5	25	133
EXA-43	W	29.200	33.200	38.500	47.300	56.480	218	13.500	5	36	167
EXA-55	W	36.600	41.700	48.800	59.400	70.930	242	18.600	5	32	176
EXA-57	W	38.600	43.900	50.800	62.500	74.630	291	18.000	5	42	220

CARACTERÍSTICAS COMUNES COMMON FEATURES

MODELO MODEL	VENTILADORES FANS		400 V POTENCIA POWER		400 V INTENSIDAD INTENSITY		DIMENSIONES DIMENSIONS (mm)			ENTRADA INLET	SALIDA OUTLET	400 V RESISTENCIAS HEATERS			
	N	Ø (mm)	Δ	Y	Δ	Y	A	B	C	Ø	Ø	W	A		
EXA-27	EXR-19	EXC-15	2	450	1.260	860	2,2	1,4	1.560	680	650	7/8"	1 5/8"	9.696	14,24
EXA-28	EXR-20	EXC-19	2	450	1.260	860	2,2	1,4	1.560	680	650	7/8"	1 5/8"	9.696	14,24
EXA-41	EXR-28	EXC-23	3	450	1.890	1.290	3,3	2,1	2.210	680	650	1 1/8"	1 5/8"	14.120	20,74
EXA-43	EXR-31	EXC-26	3	450	1.890	1.290	3,3	2,1	2.210	680	650	1 1/8"	1 5/8"	14.120	20,74
EXA-55	EXR-38	EXC-32	4	450	2.560	1.720	4,4	2,8	2.860	680	650	1 1/8"	2 1/8"	18.296	27,00
EXA-57	EXR-41	EXC-34	4	450	2.530	1.720	4,4	2,8	2.860	680	650	1 1/8"	2 1/8"	18.296	27,00

* Desagüe / Drainage: 2 x 1 1/4"

DATOS TÉCNICOS TECHNICAL INFORMATION

SERIE EXR / EXR SERIES

PASO DE ALETAS / FIN SPACING: 4,5 mm

ALTA VELOCIDAD / HIGH SPEED: 1350 r.p.m.

R-404A

MODELO MODEL	CAPACIDAD CAPACITY	ENV 328 COND.2	Tev = -5°C				SUPERFICIE SURFACE m ²	CAUDAL DE AIRE AIR FLOW m ³ /h	DARDO AIR THROW m*	VOLUMEN INTERNO INTERNAL VOLUME dm ³	PESO WEIGHT kg
			DT1 = 5	DT1 = 7	DT1 = 8	DT1 = 10					
EXR-19	W	13.600	10.132	15.369	18.768	25.024	80,9	12.100	7	17,5	92
EXR-20	W	14.400	10.728	16.272	19.872	26.496	96,9	11.800	7	22,5	112
EXR-28	W	20.600	15.347	23.278	28.428	37.904	121	18.150	7	25	128
EXR-31	W	22.200	16.539	25.086	30.636	40.848	145,3	17.700	7	36	162
EXR-38	W	27.400	20.413	30.962	37.812	50.416	161,3	24.200	7	32	170
EXR-41	W	29.400	21.903	33.222	40.572	54.096	194	23.600	7	42	214

BAJA VELOCIDAD / LOW SPEED: 1000 r.p.m.

R-404A

MODELO MODEL	CAPACIDAD CAPACITY	ENV 328 COND.2	Tev = -5°C				SUPERFICIE SURFACE m ²	CAUDAL DE AIRE AIR FLOW m ³ /h	DARDO AIR THROW m*	VOLUMEN INTERNO INTERNAL VOLUME dm ³	PESO WEIGHT kg
			DT1 = 5	DT1 = 7	DT1 = 8	DT1 = 10					
EXR-19	W	12.000	8.940	13.560	16.560	22.080	80,9	9.600	5	17,5	92
EXR-20	W	13.000	9.685	14.690	17.940	23.920	96,9	9.300	5	22,5	112
EXR-28	W	18.200	13.559	20.566	25.116	33.488	121	14.400	5	25	128
EXR-31	W	20.200	15.049	22.826	27.876	37.168	145,3	13.950	5	36	162
EXR-38	W	24.400	18.178	27.572	33.672	44.896	161,3	19.200	5	32	170
EXR-41	W	26.600	19.817	30.058	36.708	48.944	194	18.600	5	42	214

EXR

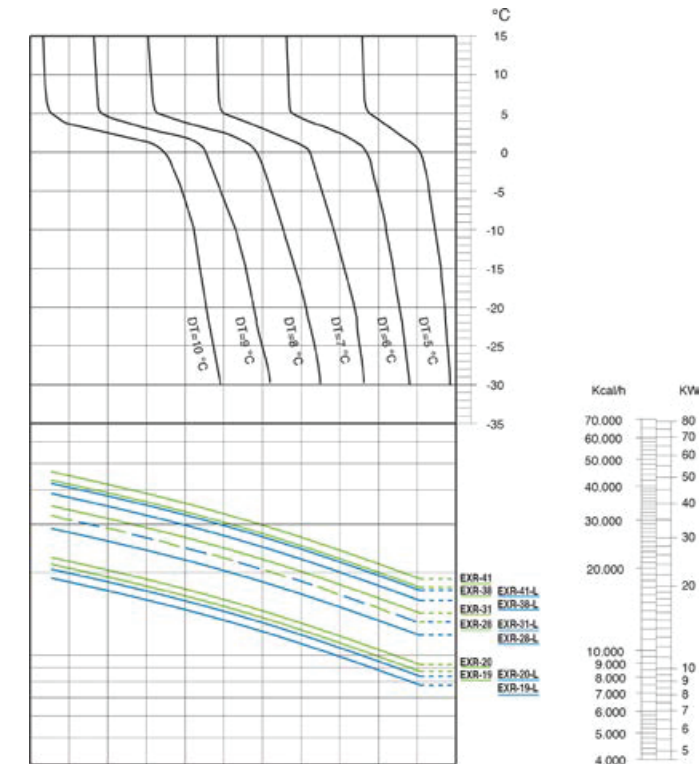

PLANO DRAWING

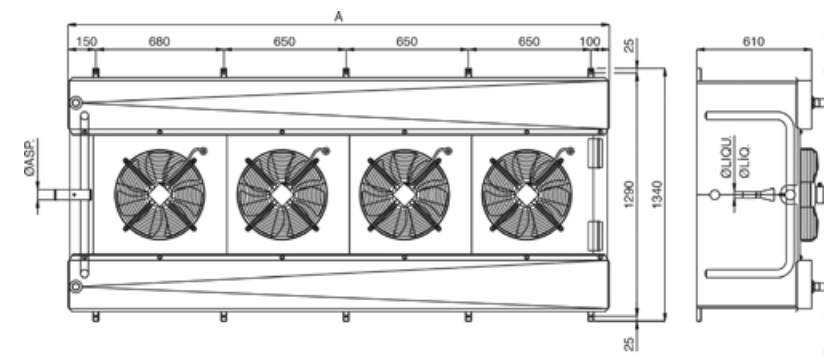

DATOS TÉCNICOS TECHNICAL INFORMATION

SERIE EXC / EXC SERIES

PASO DE ALETAS / FIN SPACING: 7 mm

ALTA VELOCIDAD / HIGH SPEED: 1350 r.p.m.

R-404A

MODELO MODEL	CAPACIDAD CAPACITY	ENV 328 COND.3	Tev = -5°C				Tev = -25°C				SUPERFICIE SURFACE m ²	CAUDAL DE AIRE AIR FLOW m ³ /h	DARDO AIR THROW m*	VOLUMEN INTERNO INTERNAL VOLUME dm ³	PESO WEIGHT kg
			DT1 = 5	DT1 = 7	DT1 = 8	DT1 = 10	DT1 = 5	DT1 = 7	DT1 = 8	DT1 = 10					
			EXC-15	W	9.600	8.352	12.864	15.803	21.120	7.584					
EXC-19	W	11.400	9.918	15.276	18.787	25.080	9.006	12.768	15.960	23.028	62,3	12.000	7	25	108
EXC-23	W	14.200	12.354	19.028	23.402	31.240	11.218	15.904	19.880	28.684	77,8	18.300	7	25	123
EXC-26	W	16.000	13.920	21.440	26.368	35.200	12.640	17.920	22.400	32.320	93,4	18.000	7	32	157
EXC-32	W	20.000	17.400	26.800	32.960	44.000	15.800	22.400	28.000	40.400	103,7	24.400	7	40	164
EXC-34	W	22.400	19.748	29.336	33.620	46.880	18.166	24.848	30.560	43.208	124,7	24.000	7	40	208

BAJA VELOCIDAD / LOW SPEED: 1000 r.p.m.

R-404A

MODELO MODEL	CAPACIDAD CAPACITY	ENV 328 COND.3	Tev = -5°C				Tev = -25°C				SUPERFICIE SURFACE m ²	CAUDAL DE AIRE AIR FLOW m ³ /h	DARDO AIR THROW m*	VOLUMEN INTERNO INTERNAL VOLUME dm ³	PESO WEIGHT kg
			DT1 = 5	DT1 = 7	DT1 = 8	DT1 = 10	DT1 = 5	DT1 = 7	DT1 = 8	DT1 = 10					
			EXC-15	W	8.600	7.482	11.524	14.175	18.920	6.794					
EXC-19	W	10.200	8.874	13.668	16.810	22.440	8.058	11.424	14.280	20.604	62,3	9.600	5	25	108
EXC-23	W	13.200	11.484	17.688	21.754	29.040	10.428	14.784	18.480	26.664	77,8	14.700	5	25	123
EXC-26	W	14.800	12.876	19.832	24.390	32.560	11.692	16.576	20.720	29.896	93,4	14.400	5	32	157
EXC-32	W	18.200	15.834	24.388	29.994	40.040	14.378	20.384	25.480	36.764	103,7	19.600	5	40	164
EXC-34	W	20.200	17.574	27.068	33.290	44.040	15.958	22.624	28.280	40.804	124,7	19.200	5	40	208

EXC en T_{ev}: -5 °C

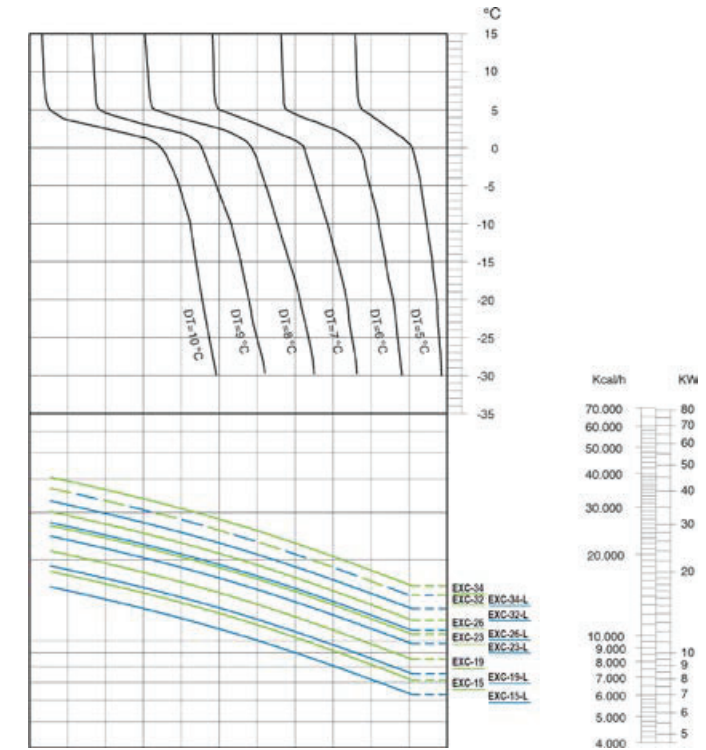

EXC en T_{ev}: -25 °C

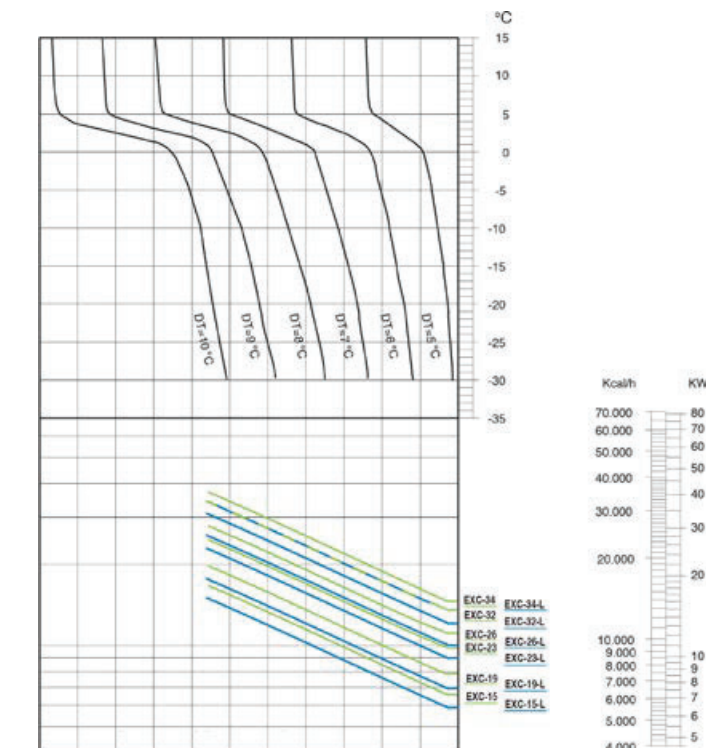

ELECCIÓN DE LA «DT» EN LOS EVAPORADORES “DT” CHOICE FOR EVAPORATORS

ELECCIÓN

- La elección de la «DT» adecuada para una cámara frigorífica en función de la humedad relativa que necesita el producto a conservar.
- Para la elección de la «DT» utilizando este diagrama debemos trazar una línea horizontal desde la humedad relativa deseada hasta cortar la curva, y desde el punto de intersección trazar una línea vertical hasta cortar al eje horizontal, con lo que obtendremos la «DT».
- A efectos de selección del evaporador, podemos considerar que la temperatura de la cámara frigorífica es igual a la temperatura de entrada del aire a la batería del evaporador, es decir: $T_{ea} = T_{cf}$.

THE CHOICE

- The choice of the suitable “DT” for an unit cooler working inside a cold storage room depends on the relative humidity the goods to be stored need.
- To select the “DT” using this chart we must draw one horizontal straight line from the relative humidity percentage wanted up to cut the plotted curve, then, we draw one downwards line from the crossover point up to cut the horizontal axis. At this point we read the “DT” value we are looking for.
- Usually designers and technicians work considering that the cold room temperature is equal to the entering air temperature at the coil’s unit cooler. Such approximation do not cause a loss of accuracy in the unit cooler’s selection. Thus, we consider: $T_{ea} = T_{cr}$ and so: $DT = T_{cr} - T_{ev}$.

